

DENSELIGHT
6 Changi North St. 2,
S498831 SINGAPORE
Tel: (65) 64157989
Fax: (65) 64154465
www.denselight.com

1310nm SLED CoS

DenseLight Part-Number: DL-CS3158A

The information contained in these documents is confidential, privileged and it may not be reproduced in whole, or in part, nor may any of the information contained therein be disclosed without the prior consent from DenseLight in writing.
DenseLight reserves the right to make product design or specifications changes without notice.

A. PRODUCT DESCRIPTION

The DenseLight DL-CS3158A series is a broadband SLED that operates in a true inherent superluminescent mode. This superluminescent property generates broader band at higher drive currents in contrast to other conventional SLEDs which are ASE-based, where high drive tends to give narrower band. Its low coherence reduces Rayleigh backscattering noise. Coupled with high power and large spectral width, it offsets photoreceiver noise and improves spatial resolution (in OCT) and measurand sensitivity (in sensors). The SLED is available in 14-pin BTF package. It is compliance with the requirements of Telcordia GR-468-CORE.

Enabled by DensePIC™ spread spectra bandgap engineering technology, future generations of DenseLight SLEDs promise higher chip powers (up to 50mW possible), and broader spectral bands (beyond 120nm). Higher levels of integration may feature integrated SLEDs with phase modulators, optical couplers and photodetectors into a complete optical sensor chipset.

For responsive prototyping enquiries please email: info@denselight.com

B. FEATURES

- Ex-fiber output power of >15mW
- Typical 3dB bandwidth of 65nm
- Spectral modulation of <0.45dB
- 14-pin BTF package
- Single mode fiber

C. APPLICATIONS

- Fiber Optic Gyroscope
- Optical Test Instrument
- Fiber Optic Sensors
- Fiber Optic Communications
- Optical Coherence Tomography
- Biomedical Imaging Device
- Clinical Healing Equipment

The information contained in these documents is confidential, privileged and it may not be reproduced in whole, or in part, nor may any of the information contained therein be disclosed without the prior consent from DenseLight in writing.
DenseLight reserves the right to make product design or specifications changes without notice.

E. ABSOLUTE MAXIMUM RATINGS

Exposure to maximum rating and operation exceeding the absolute maximum rating can cause degradation in device performance leading to permanent damage to the device.

Parameter	Symbol	Condition	Min	Max	Unit
Reverse voltage	V_R			2	V
Forward current	I_F			550	mA
Forward voltage	V_F	I_{op}		2.8	V
Case temperature	T_C	I_{op}	-40	65	°C
SLED temperature ¹	T_{SLED}	I_{op}	0	70	°C
Thermoelectric cooler voltage	V_{TEC}			3.56	V
Thermoelectric cooler current	I_{TEC}			2.56	A
Storage temperature	T_{stg}	Unbiased	-40	85	°C
Storage humidity			5	85	%RH
Electro static discharge (ESD)	V_{ESD}	Human body model		500	V
Lead soldering temperature	S_{temp}			260	°C
Lead soldering time	S_{time}			10	sec

F. SPECIFICATIONS ($T_{SLED} = 25\text{ °C}$)

Parameter	Symbol	Condition	Min	Typ	Max	Unit
Operating Current	I_{op}				500	mA
Forward voltage	V_F	I_{op}			2.4	V
Power in SMF	P_o	I_{op}	15			mW
Central wavelength	λ	P_o	1290	1310	1330	nm
Bandwidth	B_{FWHM}	P_o	60	65		nm
Spectrum modulation	R	P_o			0.45	dB
Thermistor resistance	R_{therm}	$T = 25\text{ °C}$	9.5	10	10.5	k Ω
Thermoelectric cooler voltage	V_{TEC}	I_{op}			2.9	V
Thermoelectric cooler current	I_{TEC}	I_{op}			1.6	A

The information contained in these documents is confidential, privileged and it may not be reproduced in whole, or in part, nor may any of the information contained therein be disclosed without the prior consent from DenseLight in writing.
DenseLight reserves the right to make product design or specifications changes without notice.

F. PACKAGE

BTF package

Part	Description
Package type	BTF
Fiber:	SMF-28
MFD	9 μ m
Cladding diameter	125 μ m
Coating diameter	245 μ m
Jacket	900 μ m loose tube
Fiber pigtail length	1m
Fiber bending radius	>40mm
Connector	FC/APC
Dimensions	See figure

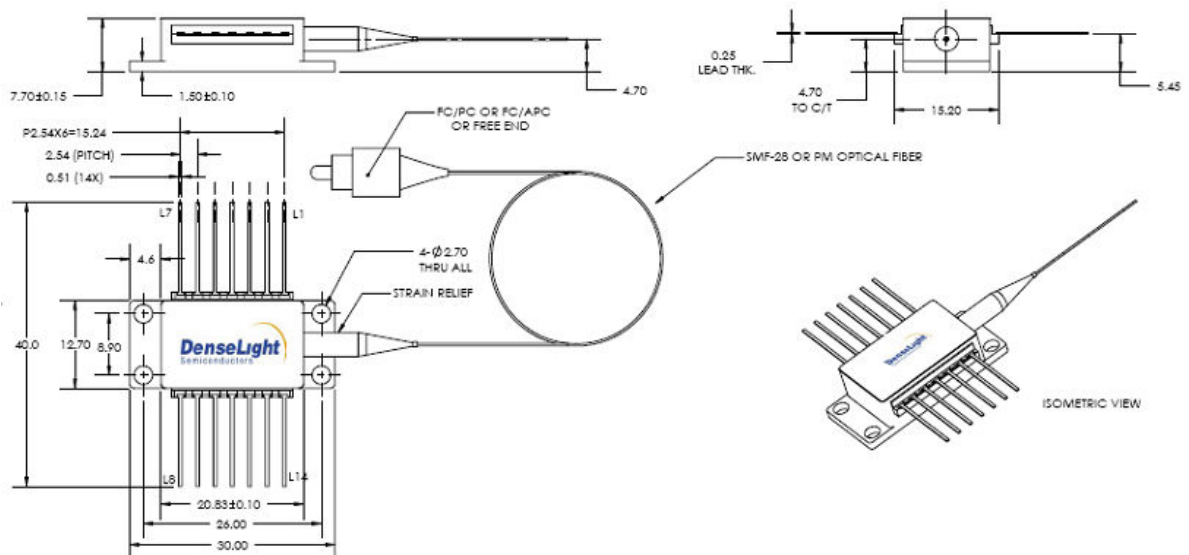

Pin Assignment	
1	TEC+
2	THERMISTOR
3	-
4	-
5	THERMISTOR
6	-
7	-
8	-
9	-
10	SLED ANODE +
11	SLED CATHODE -
12	-
13	CASE
14	TEC -

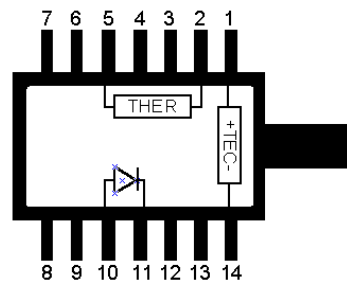

The information contained in these documents is confidential, privileged and it may not be reproduced in whole, or in part, nor may any of the information contained therein be disclosed without the prior consent from DenseLight in writing.

DenseLight reserves the right to make product design or specifications changes without notice.

H. THERMISTOR RESISTANCE VS TEMPERATURE

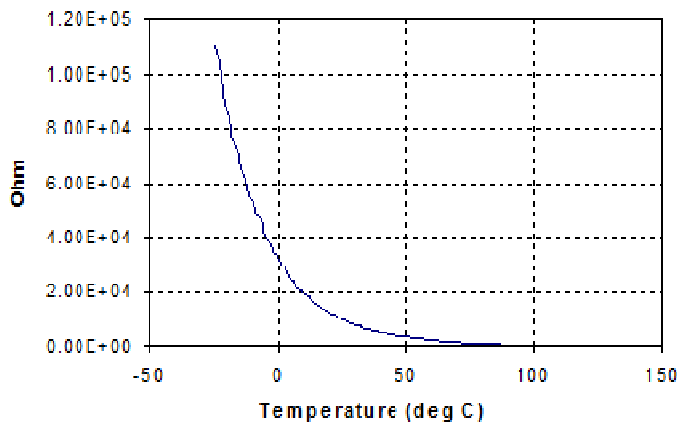

I. TYPICAL PERFORMANCE

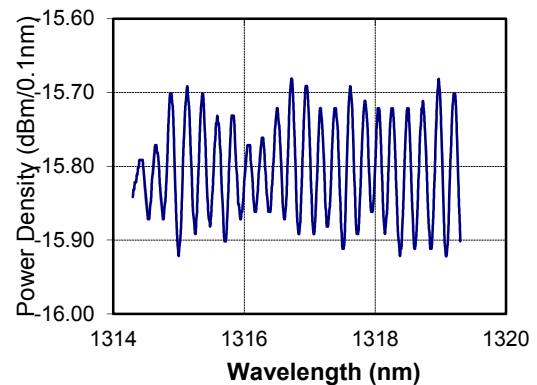
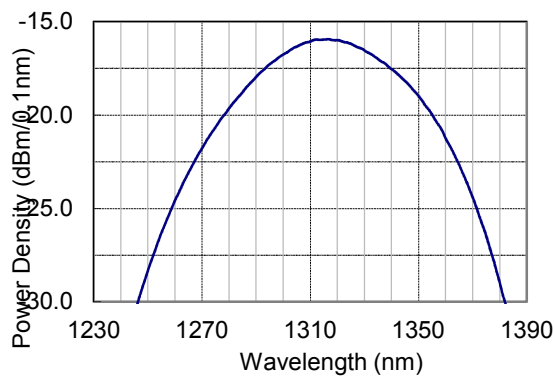
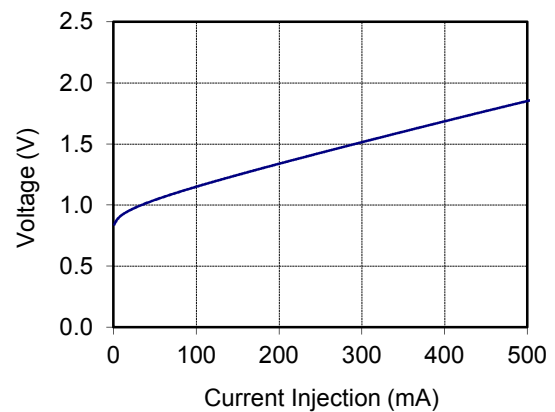
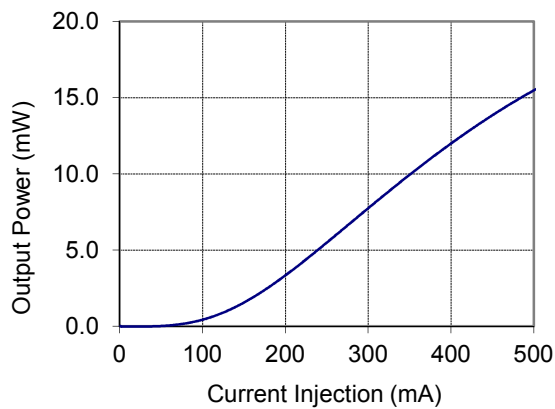

The information contained in these documents is confidential, privileged and it may not be reproduced in whole, or in part, nor may any of the information contained therein be disclosed without the prior consent from DenseLight in writing. DenseLight reserves the right to make product design or specifications changes without notice.